

REVISION HISTORY				
REV.	DESCRIPTION	DATE	ECO	BY

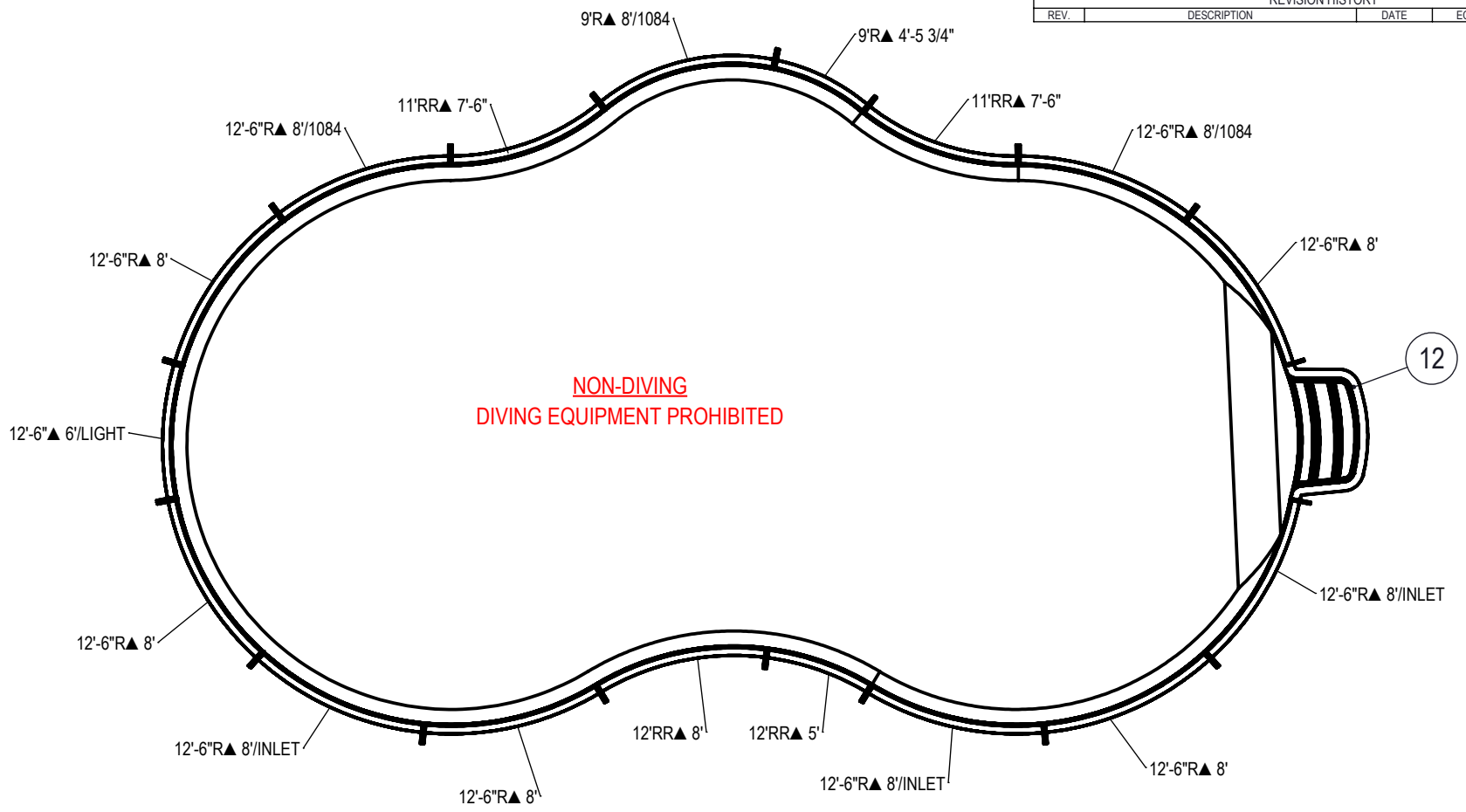

**NON-DIVING
DIVING EQUIPMENT PROHIBITED**

NOTES:

- THESE ARE FINISHED DIMENSIONS READY FOR THE LINER.
- DIMENSIONS ARE FROM INSIDE POOL PANELS.
- ROPE AND FLOAT ASSEMBLY SHOULD BE INSTALLED IN ACCORDANCE WITH CURRENT ANSI/ASPS/ICC REGULATIONS
- HYDRA LINER TRACK FOR STEPS IS INSTALLED WITH THE BARB FACING THE RISER WALL ON THE STEP.

EXCAVATION NOTES:

- ROUGH EXCAVATION SHOULD BE 2" DEEPER IN EACH INSTANCE.
- SOIL TO HAVE MINIMUM BEARING CAPACITY OF 1500 PSF.
- LOCATE TOP OF POOL AT LEAST 6" ABOVE THE SURROUNDING LAND ELEVATION.
- SEE "OVER DIG DETAIL" FOR EXCAVATION AROUND POOL.
- FILL VOIDS UNDER BASE OF PANELS AND TAMP WELL.
- BACK FILL WITH NON-EXPANSIVE MATERIAL.
- FOLLOW ALL CURRENT ANSI / APSP / ICC GUIDELINES FOR RESIDENTIAL POOLS

IMPORTANT NOTES:

THIS DOCUMENT IS FOR ILLUSTRATIVE PURPOSES ONLY. THE DEALER OR CONTRACTOR WHO SELLS OR INSTALLS YOUR POOL IS AN INDEPENDENT CONTRACTOR AND IS NOT AN AGENT OF THE MANUFACTURER. THE CONSTRUCTION METHODS ILLUSTRATED HERE ARE SUGGESTIONS AND APPLY ONLY TO NORMAL GROUND CONDITIONS. THERE MAY BE ADDITIONAL PRECAUTIONS AND/OR METHODS OF CONSTRUCTION. PROPER INSTALLATION IS THE RESPONSIBILITY OF THE DEALER/BUILDER/CONTRACTOR.

ITEM	FILE NAME	DESCRIPTION	CUSTOMER DRAWING #	VENDOR PART #	QTY.
1	BOLT, PACK	BOLT, FLANGE, 3/8-16 X 1", PACK (50)	HPS1916	HPS1916	4
2	SBRACE	BRACE, FOLD OVER WITH TURNBUCKLE, STEEL, HPSFOB	HPSFOB	HPSFOB	18
3	PANEL, RR	PANEL, 11' REVERSE RADIUS, 7'-6" LONG, 600 SERIES	HPSCRR8	00008214	2
4	PANEL, RR	PANEL, 12' REVERSE RADIUS, 5' LONG, 600 SERIES	HPSCRR6	00002002	1
5	PANEL, RR	PANEL, 12' REVERSE RADIUS, 8' LONG, 600 SERIES	HPSCRR8	00002026	1
6	PANEL, RADIUS	PANEL, 12'-6" RADIUS, 6' LONG, 600 SERIES	HPSCR7	00007640	1
7	PANEL, RADIUS	PANEL, 12'-6" RADIUS, 8' LONG, 1084, 600 SERIES	HPSCR8	00008145	2
8	PANEL, RADIUS	PANEL, 12'-6" RADIUS, 8' LONG, 600 SERIES	HPSCR8	00007638	5
9	PANEL, RADIUS	PANEL, 12'-6" RADIUS, 8' LONG, INLET, 600 SERIES	HPSCR8	00008146	3
10	PANEL, RADIUS	PANEL, 9' RADIUS, 4'-5 3/4" LONG, 600 SERIES	HPSCR5	00005245	1
11	PANEL, RADIUS	PANEL, 9' RADIUS, 8' LONG, 1084, 600 SERIES	HPS9R884	00000272	1
12	HS303N	STEP, 9' RADIUS, 3 TREAD, CANTILEVER	HS303N	HS303N	1

ENGINEERING DRAWING NUMBER: 00017701	WEIGHT:	UNLESS OTHERWISE SPECIFIED DIMENSIONS ARE IN INCHES TOLERANCES DECIMALS: X ± .1 XX ± .01 XXX ± .001 XXXX ± .0005 ANGULAR: X ± 0.5 THIRD ANGLE PROJECTION	DESIGNED BY:	BUMPHREY	CREATION DATE:	8/12/2014	HYDRA POOLS
	VOLUME:		DETAILED BY:	BUMPHREY	DETAILED DATE:	2/26/2018	
	COLOR:		LAST REVISED BY:	bumphrey	LAST REVISED DATE:	2/26/2018	
	HEAT TREAT:		MATERIAL:				
	FINISH:						
TEXTURE:						TITLE: LAYOUT, 25' X 50', LAGOON, LEFT, 4' DEEP, FLAT BOTTOM, HS303N, LIGHT, 3-1084, 3-INLET, 600 SERIES	
						PART NUMBER:	00017701
						SCALE:	1:192
						SHEET:	1 OF 4
						SIZE:	A

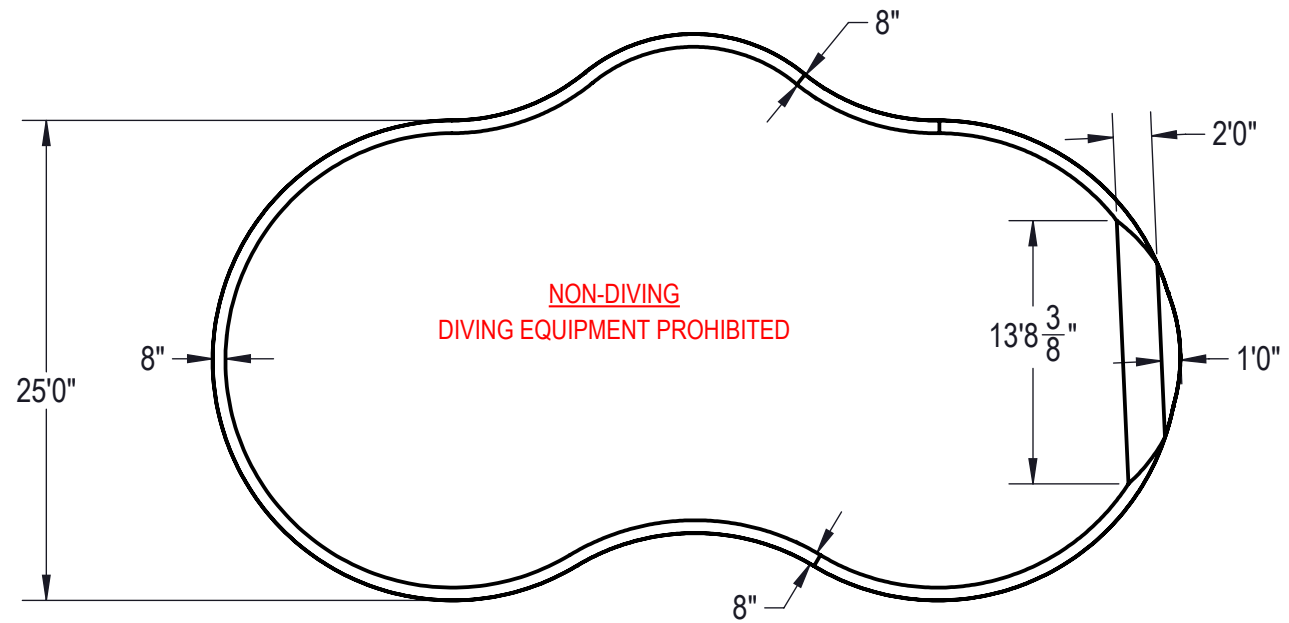
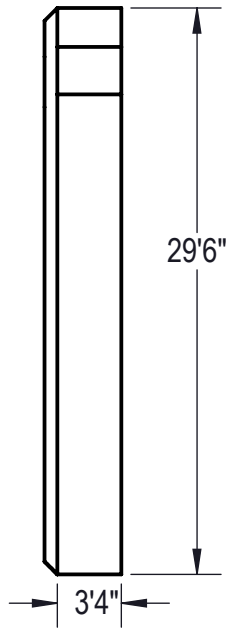

Area: 1133.80ft ^2
Perimeter: 132.48ft
Volume = 33642 US gallons

NOTES:

1. THESE ARE FINISHED DIMENSIONS READY FOR THE LINER.
2. DIMENSIONS ARE FROM INSIDE POOL PANELS.
3. ROPE AND FLOAT ASSEMBLY SHOULD BE INSTALLED IN ACCORDANCE WITH CURRENT ANSI/ASPS/ICC REGULATIONS
4. HYDRA LINER TRACK FOR STEPS IS INSTALLED WITH THE BARB FACING THE RISER WALL ON THE STEP.

EXCAVATION NOTES:

5. ROUGH EXCAVATION SHOULD BE 2" DEEPER IN EACH INSTANCE.
6. SOIL TO HAVE MINIMUM BEARING CAPACITY OF 1500 PSF.
7. LOCATE TOP OF POOL AT LEAST 6" ABOVE THE SURROUNDING LAND ELEVATION.
8. SEE "OVER DIG DETAIL" FOR EXCAVATION AROUND POOL.
9. FILL VOIDS UNDER BASE OF PANELS AND TAMP WELL.
10. BACK FILL WITH NON-EXPANSIVE MATERIAL.
11. FOLLOW ALL CURRENT ANSI / APSP / ICC GUIDELINES FOR RESIDENTIAL POOLS

IMPORTANT NOTES:

THIS DOCUMENT IS FOR ILLUSTRATIVE PURPOSES ONLY. THE DEALER OR CONTRACTOR WHO SELLS OR INSTALLS YOUR POOL IS AN INDEPENDENT CONTRACTOR AND IS NOT AN AGENT OF THE MANUFACTURER. THE CONSTRUCTION METHODS ILLUSTRATED HERE ARE SUGGESTIONS AND APPLY ONLY TO NORMAL GROUND CONDITIONS. THERE MAY BE ADDITIONAL PRECAUTIONS AND/OR METHODS OF CONSTRUCTION. PROPER INSTALLATION IS THE RESPONSIBILITY OF THE DEALER/BUILDER/CONTRACTOR.

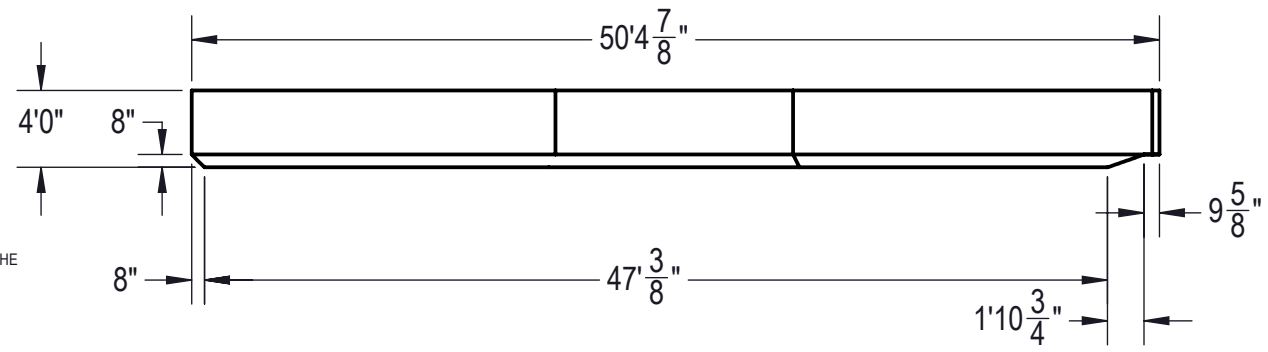

ENGINEERING DRAWING NUMBER: 00017701	WEIGHT:	UNLESS OTHERWISE SPECIFIED DIMENSIONS ARE IN INCHES TOLERANCES DECIMALS: X ± .1 XX ± .01 XXX ± .001 XXXX ± .0005 ANGULAR: X ± 0.5 THIRD ANGLE PROJECTION	DESIGNED BY:	CREATION DATE:	HYDRA POOLS		
	lbs		BUMPHREY	8/12/2014			
	VOLUME:			DETAILED BY:	DETAILED DATE:	TITLE: LAYOUT, 25' X 50', LAGOON, LEFT, 4' DEEP, FLAT BOTTOM, HS303N, LIGHT, 3-1084, 3-INLET, 600 SERIES	
	Inch ³			BUMPHREY	2/26/2018		
	NA			LAST REVISED BY:	LAST REVISED DATE:		
HEAT TREAT:		bumphrey	2/26/2018	SCALE: 1:192	SIZE: A		
FINISH:				SHEET: 2 OF 4			
TEXTURE:							

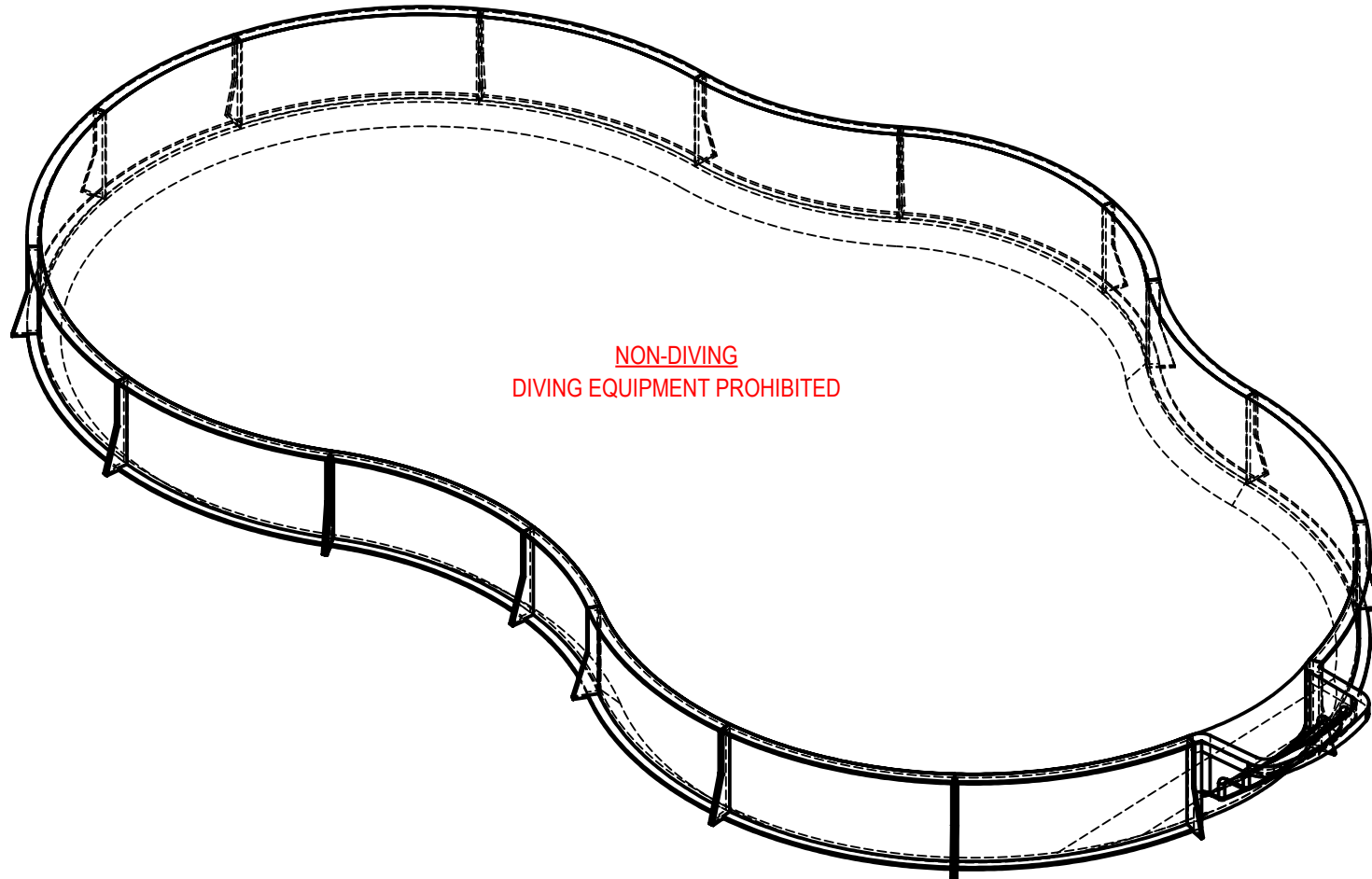

**NON-DIVING
DIVING EQUIPMENT PROHIBITED**

ENGINEERING DRAWING NUMBER: 00017701	WEIGHT:	UNLESS OTHERWISE SPECIFIED DIMENSIONS ARE IN INCHES TOLERANCES DECIMALS: X ± .1 XX ± .01 XXX ± .001 XXXX ± .0005 ANGULAR: X ± 0.5 THIRD ANGLE PROJECTION 	DESIGNED BY:	CREATION DATE:	HYDRA POOLS TITLE: LAYOUT, 25' X 50', LAGOON, LEFT, 4' DEEP, FLAT BOTTOM, HS303N, LIGHT, 3-1084, 3-INLET, 600 SERIES PART NUMBER: 00017701	
	lbs		BUMPHREY	8/12/2014		
	VOLUME:		Detailed by:	Detailed Date:		
	Inch ³		BUMPHREY	2/26/2018		
	COLOR:		Last Revised By:	Last Revised Date:		
	NA		bumphrey	2/26/2018		
HEAT TREAT:	MATERIAL:					
NA					SCALE:	SIZE:
FINISH:					1:192	A
NA					SHEET:	
TEXTURE:					3 OF 4	
NA						

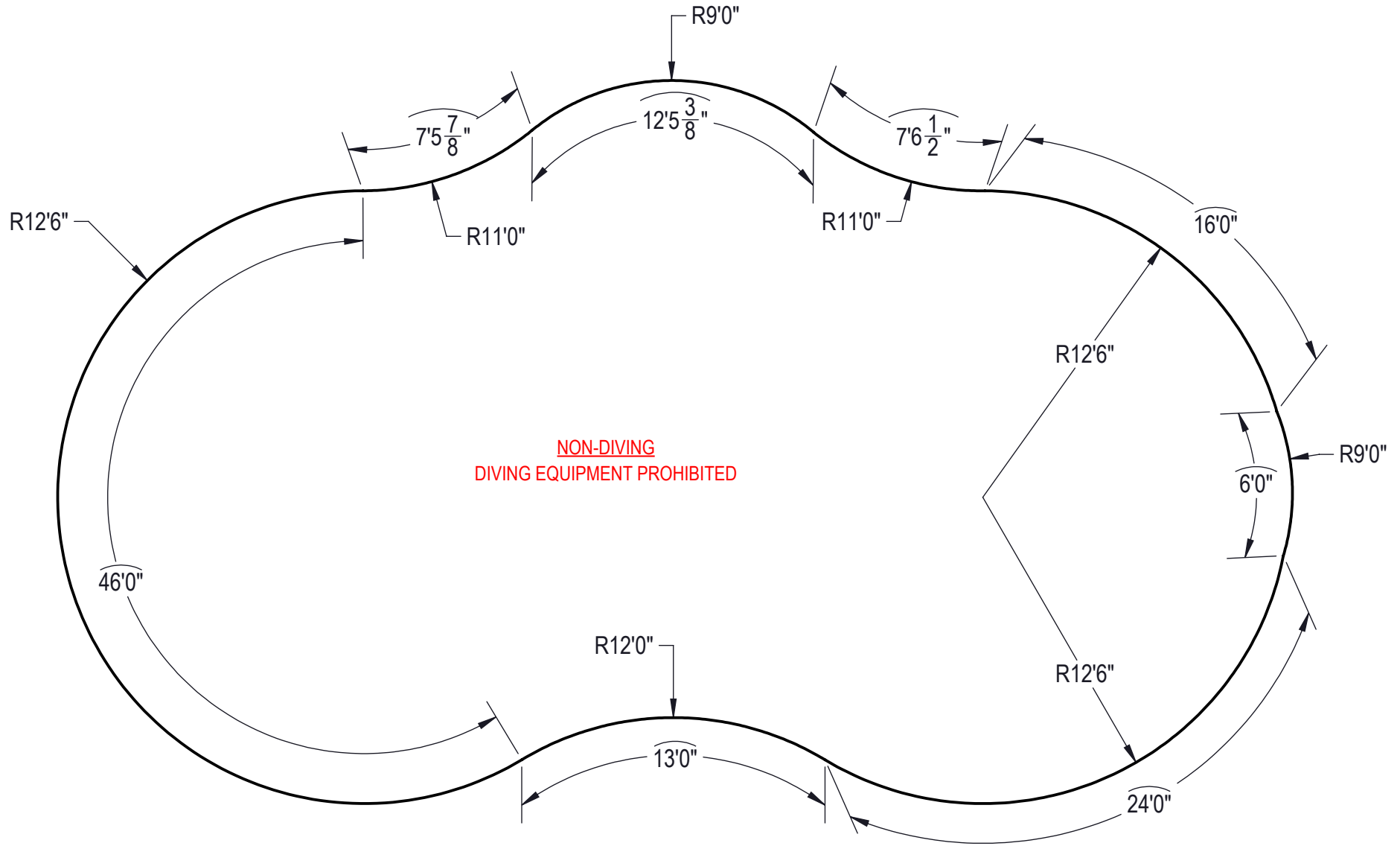

**NON-DIVING
 DIVING EQUIPMENT PROHIBITED**

ENGINEERING DRAWING NUMBER: 00017701	WEIGHT:	UNLESS OTHERWISE SPECIFIED DIMENSIONS ARE IN INCHES TOLERANCES DECIMALS: X ± .1 XX ± .01 XXX ± .001 XXXX ± .0005 ANGULAR: X ± 0.5 THIRD ANGLE PROJECTION 	DESIGNED BY:	CREATION DATE:	HYDRA POOLS
	lbs		BUMPHREY	8/12/2014	
	VOLUME:		DETAILED BY:	DETAILED DATE:	
	Inch ³		BUMPHREY	2/26/2018	TITLE: LAYOUT, 25' X 50', LAGOON, LEFT, 4' DEEP, FLAT BOTTOM, HS303N, LIGHT, 3-1084, 3-INLET, 600 SERIES
	COLOR:		LAST REVISED BY:	LAST REVISED DATE:	
	NA		bumphrey	2/26/2018	
HEAT TREAT:	MATERIAL:	PART NUMBER: 00017701			
NA		SCALE:	SIZE:		
FINISH:		1:192	A		
TEXTURE:		4 OF 4			