

REVISION HISTORY				
REV.	DESCRIPTION	DATE	ECO	BY

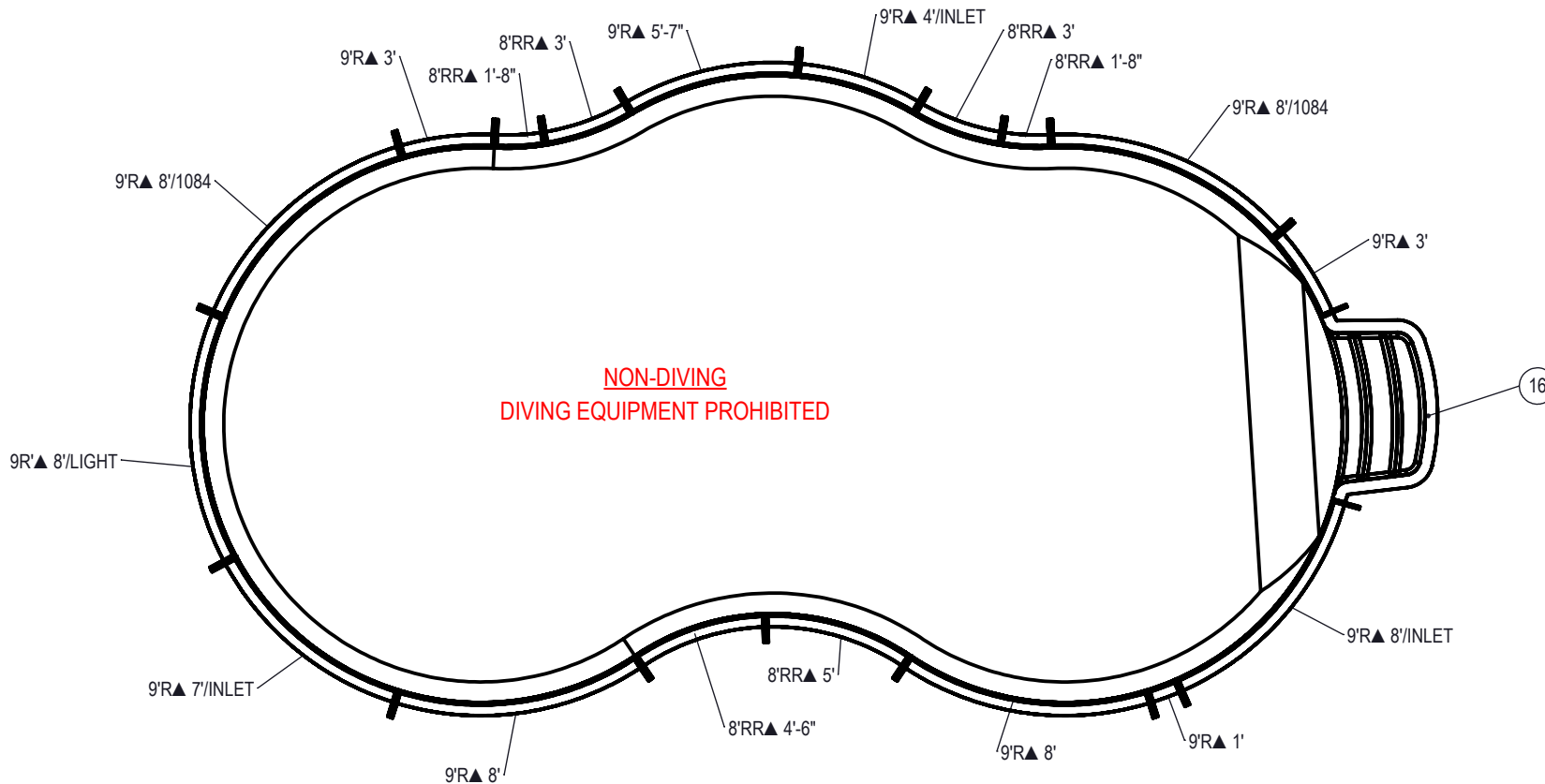

NOTES:

- THESE ARE FINISHED DIMENSIONS READY FOR THE LINER.
- DIMENSIONS ARE FROM INSIDE POOL PANELS.
- ROPE AND FLOAT ASSEMBLY SHOULD BE INSTALLED IN ACCORDANCE WITH CURRENT ANSI/ASPS/ICC REGULATIONS
- HYDRA LINER TRACK FOR STEPS IS INSTALLED WITH THE BARB FACING THE RISER WALL ON THE STEP.

EXCAVATION NOTES:

- ROUGH EXCAVATION SHOULD BE 2" DEEPER IN EACH INSTANCE.
- SOIL TO HAVE MINIMUM BEARING CAPACITY OF 1500 PSF.
- LOCATE TOP OF POOL AT LEAST 6" ABOVE THE SURROUNDING LAND ELEVATION.
- SEE "OVER DIG DETAIL" FOR EXCAVATION AROUND POOL.
- FILL VOIDS UNDER BASE OF PANELS AND TAMP WELL.
- BACK FILL WITH NON-EXPANSIVE MATERIAL.
- FOLLOW ALL CURRENT ANSI / APSP / ICC GUIDELINES FOR RESIDENTIAL POOLS

IMPORTANT NOTES:

THIS DOCUMENT IS FOR ILLUSTRATIVE PURPOSES ONLY. THE DEALER OR CONTRACTOR WHO SELLS OR INSTALLS YOUR POOL IS AN INDEPENDENT CONTRACTOR AND IS NOT AN AGENT OF THE MANUFACTURER. THE CONSTRUCTION METHODS ILLUSTRATED HERE ARE SUGGESTIONS AND APPLY ONLY TO NORMAL GROUND CONDITIONS. THERE MAY BE ADDITIONAL PRECAUTIONS AND/OR METHODS OF CONSTRUCTION. PROPER INSTALLATION IS THE RESPONSIBILITY OF THE DEALER/BUILDER/CONTRACTOR.

ITEM	FILE NAME	DESCRIPTION	CUSTOMER DRAWING #	VENDOR PART #	QTY.
1	BOLT, PACK	BOLT, FLANGE, 3/8-16 X 1", PACK (50)	HPS1916	HPS1916	5
2	SBRACE	BRACE, FOLD OVER WITH TURNBUCKLE, STEEL, HPSFOB	HPSFOB	HPSFOB	19
3	PANEL, RR	PANEL, 8' REVERSE RADIUS, 1'-8" LONG, 600 SERIES	HPSCRR2	00006614	2
4	PANEL, RR	PANEL, 8' REVERSE RADIUS, 3' LONG, 600 SERIES	HPSD8RR3	00001618	2
5	PANEL, RR	PANEL, 8' REVERSE RADIUS, 4'-6" LONG, 600 SERIES	HPSD8RR4	00001715	1
6	PANEL, RR	PANEL, 8' REVERSE RADIUS, 5' LONG, 600 SERIES	HPSD8RR5	00000143	1
7	PANEL, RADIUS	PANEL, 9' RADIUS, 1' LONG, 600 SERIES	HPSD9R1	00000348	1
8	PANEL, RADIUS	PANEL, 9' RADIUS, 3' LONG, 600 SERIES	HPSD9R3	00000351	2
9	PANEL, RADIUS	PANEL, 9' RADIUS, 4' LONG, INLET OR LED, 600 SERIES	HPSCR5	00006106	1
10	PANEL, RADIUS	PANEL, 9' RADIUS, 5'-7" LONG, 600 SERIES	HPSCR6	00006975	1
11	PANEL, RADIUS	PANEL, 9' RADIUS, 7' LONG, INLET, 600 SERIES	HPSCR8	00008238	1
12	PANEL, RADIUS	PANEL, 9' RADIUS, 8' LONG, 1084, 600 SERIES	HPS9R884	00000272	2
13	PANEL, RADIUS	PANEL, 9' RADIUS, 8' LONG, 600 SERIES	HPSD9R8	00000395	2
14	PANEL, RADIUS	PANEL, 9' RADIUS, 8' LONG, LIGHT, 600 SERIES	HPSD9R8L	00000398	1
15	PANEL, RADIUS	PANEL, 9' RADIUS, 8', INLET OR LED, 600 SERIES	HPS9R8I	00000275	1
16	HS303N	STEP, 9' RADIUS, 3 TREAD, CANTILEVER	HS303N	HS303N	1

ENGINEERING DRAWING NUMBER: 00017696	WEIGHT: lbs	UNLESS OTHERWISE SPECIFIED DIMENSIONS ARE IN INCHES TOLERANCES DECIMALS: X ± .1 XX ± .01 XXX ± .001 XXXX ± .0005 ANGULAR: X ± 0.5 THIRD ANGLE PROJECTION	DESIGNED BY: BUMPHREY	CREATION DATE: 6/7/2013
	VOLUME: Inch ³		DETAILED BY: BUMPHREY	DETAILED DATE: 2/26/2018
	COLOR:		LAST REVISED BY: bumphrey	LAST REVISED DATE: 2/26/2018
	HEAT TREAT:		MATERIAL:	
	FINISH:			
	TEXTURE:			

HYDRA POOLS	
TITLE: LAYOUT, 18' X 37', LAGOON, LEFT, 4' DEEP, FLAT BOTTOM, HS106N, LIGHT, 2-1084, 3-INLET, 600 SERIES	
PART NUMBER: 00017696	SCALE: 1:96 SHEET: 1 OF 4 SIZE: A

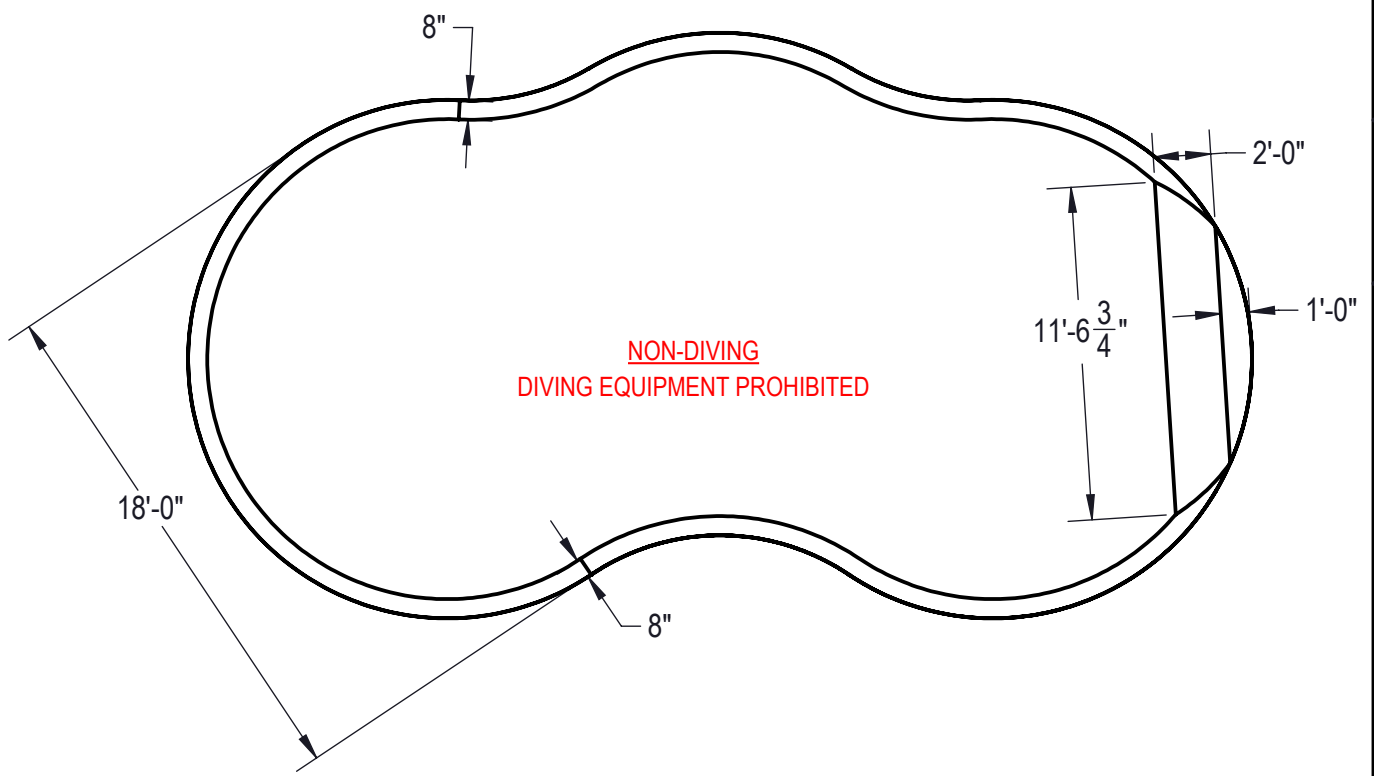
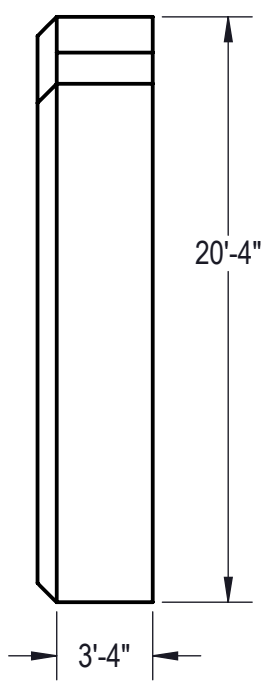

Area: 589.03ft ^2
Perimeter: 96.42ft
Volume = 17408 US gallons

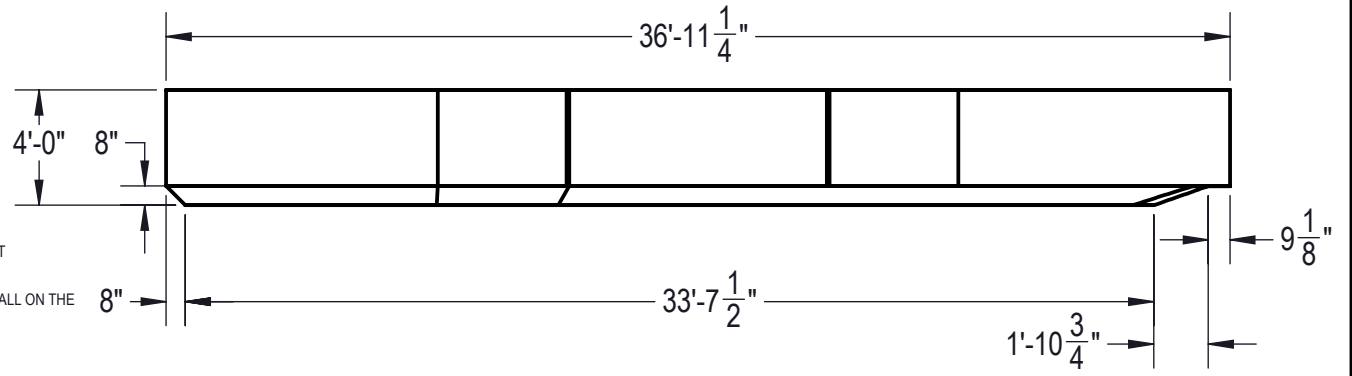

NOTES:

1. THESE ARE FINISHED DIMENSIONS READY FOR THE LINER.
2. DIMENSIONS ARE FROM INSIDE POOL PANELS.
3. ROPE AND FLOAT ASSEMBLY SHOULD BE INSTALLED IN ACCORDANCE WITH CURRENT ANSI/ASPS/ICC REGULATIONS
4. HYDRA LINER TRACK FOR STEPS IS INSTALLED WITH THE BARB FACING THE RISER WALL ON THE STEP.

EXCAVATION NOTES:

5. ROUGH EXCAVATION SHOULD BE 2" DEEPER IN EACH INSTANCE.
6. SOIL TO HAVE MINIMUM BEARING CAPACITY OF 1500 PSF.
7. LOCATE TOP OF POOL AT LEAST 6" ABOVE THE SURROUNDING LAND ELEVATION.
8. SEE "OVER DIG DETAIL" FOR EXCAVATION AROUND POOL.
9. FILL VOIDS UNDER BASE OF PANELS AND TAMP WELL.
10. BACK FILL WITH NON-EXPANSIVE MATERIAL.
11. FOLLOW ALL CURRENT ANSI / APSP / ICC GUIDELINES FOR RESIDENTIAL POOLS

IMPORTANT NOTES:

THIS DOCUMENT IS FOR ILLUSTRATIVE PURPOSES ONLY. THE DEALER OR CONTRACTOR WHO SELLS OR INSTALLS YOUR POOL IS AN INDEPENDENT CONTRACTOR AND IS NOT AN AGENT OF THE MANUFACTURER. THE CONSTRUCTION METHODS ILLUSTRATED HERE ARE SUGGESTIONS AND APPLY ONLY TO NORMAL GROUND CONDITIONS. THERE MAY BE ADDITIONAL PRECAUTIONS AND/OR METHODS OF CONSTRUCTION. PROPER INSTALLATION IS THE RESPONSIBILITY OF THE DEALER/BUILDER/CONTRACTOR.

ENGINEERING DRAWING NUMBER: 00017696	WEIGHT:	UNLESS OTHERWISE SPECIFIED DIMENSIONS ARE IN INCHES TOLERANCES DECIMALS: X ± .1 XX ± .01 XXX ± .001 XXXX ± .0005 ANGULAR: X ± 0.5 THIRD ANGLE PROJECTION 	DESIGNED BY:	CREATION DATE:	HYDRA POOLS		
	VOLUME:		BUMPHREY	1/3/2012			
	Inch ³			DETAILED BY:	DETAILED DATE:	TITLE: LAYOUT, 18' X 37', LAGOON, LEFT, 4' DEEP, FLAT BOTTOM, HS106N, LIGHT, 2-1084, 3-INLET, 600 SERIES	
	COLOR:			BUMPHREY	2/26/2018		
	HEAT TREAT:			LAST REVISED BY:	LAST REVISED DATE:		
NA		bumphrey	2/26/2018	PART NUMBER:	SCALE:	SIZE:	
NA		MATERIAL:		00017696	1:96	A	
NA					SHEET:		
NA					2 OF 4		

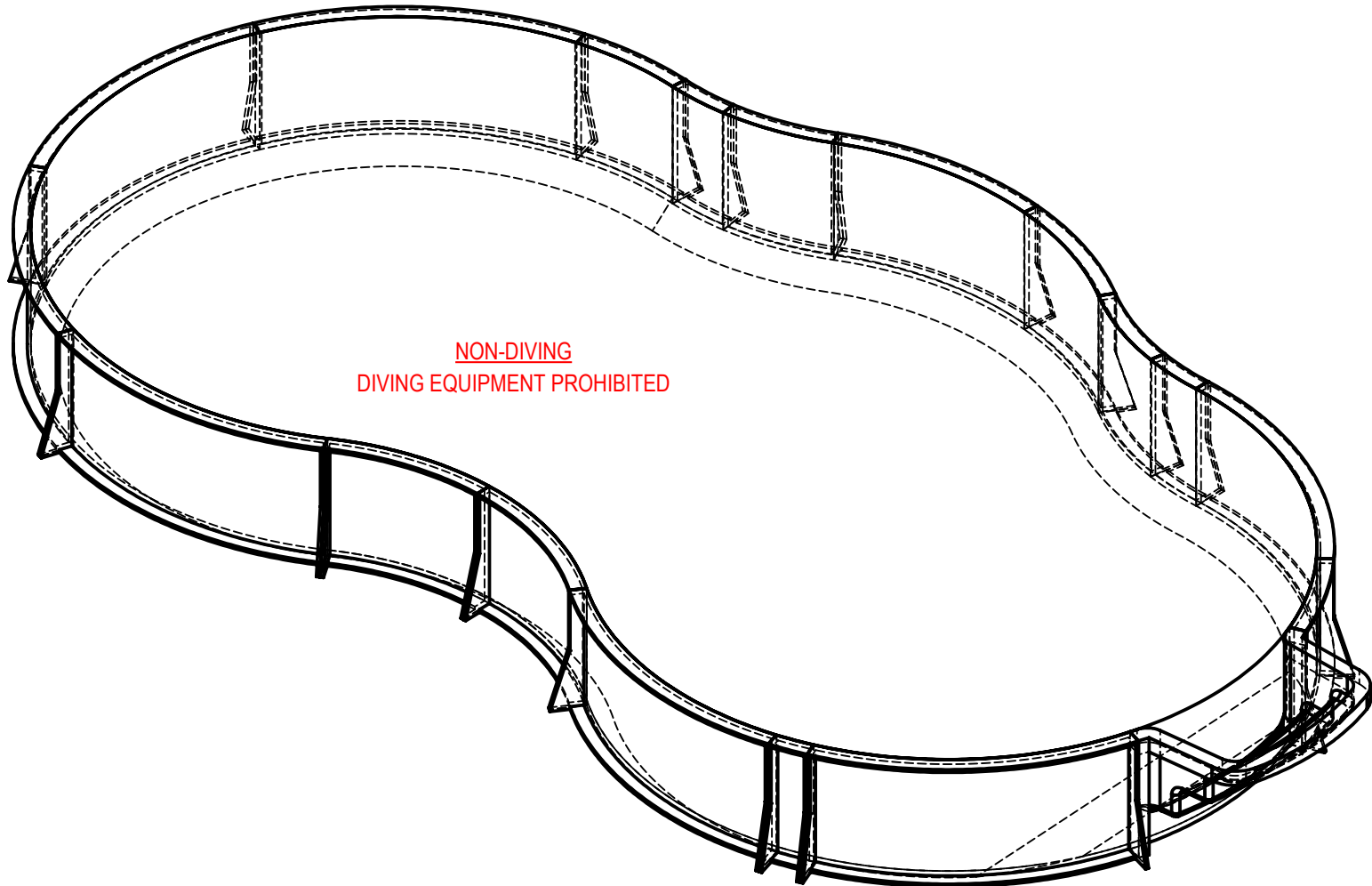

**NON-DIVING
 DIVING EQUIPMENT PROHIBITED**

ENGINEERING DRAWING NUMBER: 00017696	WEIGHT:	UNLESS OTHERWISE SPECIFIED DIMENSIONS ARE IN INCHES TOLERANCES DECIMALS: X ± .1 XX ± .01 XXX ± .001 XXXX ± .0005 ANGULAR: X ± 0.5 THIRD ANGLE PROJECTION 	DESIGNED BY:	CREATION DATE:	HYDRA POOLS
	lbs		BUMPHREY	6/7/2013	
	VOLUME:		Detailed by:	Detailed Date:	
	Inch ³		BUMPHREY	2/26/2018	
	COLOR:		LAST REVISED BY:	LAST REVISED DATE:	TITLE: LAYOUT, 18' X 37', LAGOON, LEFT, 4' DEEP, FLAT BOTTOM, HS106N, LIGHT, 2-1084, 3-INLET, 600 SERIES
	HEAT TREAT:		bumphrey	2/26/2018	
FINISH:	MATERIAL:		PART NUMBER:	SCALE:	SIZE:
TEXTURE:			00017696	1:96	A
				SHEET:	
				3 OF 4	

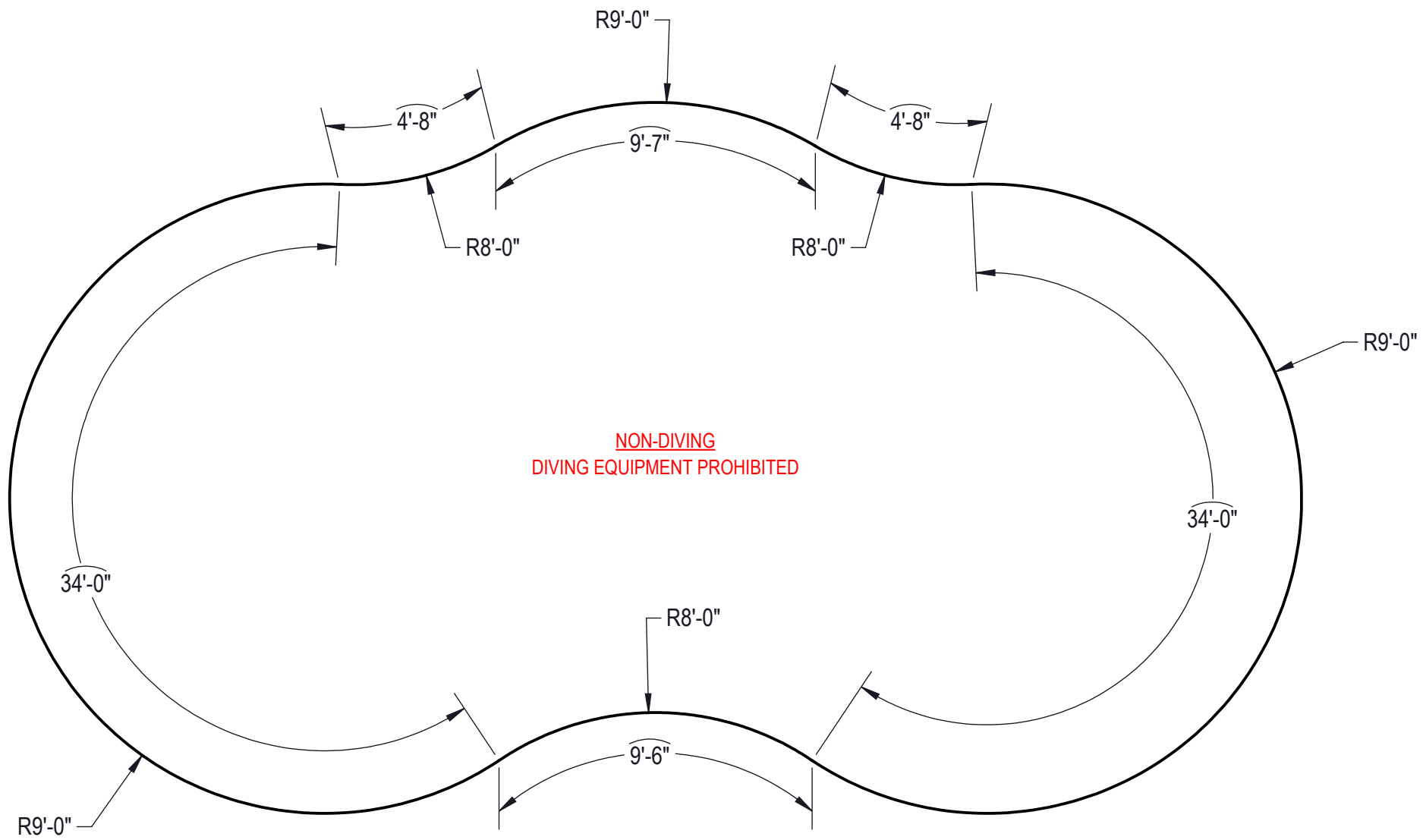

**NON-DIVING
 DIVING EQUIPMENT PROHIBITED**

ENGINEERING DRAWING NUMBER: 00017696	WEIGHT:	UNLESS OTHERWISE SPECIFIED DIMENSIONS ARE IN INCHES TOLERANCES DECIMALS: X ± .1 XX ± .01 XXX ± .001 XXXX ± .0005 ANGULAR: X ± 0.5 THIRD ANGLE PROJECTION 	DESIGNED BY:	CREATION DATE:	HYDRA POOLS
	lbs		BUMPHREY	1/3/2012	
	VOLUME:		DETAILED BY:	DETAILED DATE:	
	Inch ³		BUMPHREY	2/26/2018	TITLE: LAYOUT, 18' X 37', LAGOON, LEFT, 4' DEEP, FLAT BOTTOM, HS106N, LIGHT, 2-1084, 3-INLET, 600 SERIES
	COLOR:		LAST REVISED BY:	LAST REVISED DATE:	
	NA		bumphrey	2/26/2018	
HEAT TREAT:	MATERIAL:	PART NUMBER:		SCALE:	SIZE:
NA		00017696		1:96	A
FINISH:				SHEET:	
NA				4 OF 4	
TEXTURE:					
NA					